

# COMBITRAILER CT-511-S



(The picture is not the standard execution)



## Technische gegevens

Geschikt voor

Schoteldruk

Max. aslast per as

Tot. toegestane massa

Leeggewicht

Nuttig laadvermogen

Schotelhoogte

Chassishoogte

Bandenmaat

Electr. Aansluitingen

Stuuras (-sen) op as

Liftas (-sen) op as

Douanestand



## Technische Daten

Geeignet für

Sattellast

Max. Achslast pro Achse

Gesamt zulässige Masse

Leergewicht

Nutzlast

Sattelhöhe

Chassishöhe

Reifengröße

Elektrische Anschlüsse

Lenkachse (-n) auf Achse

Liftachse (-n) auf Achse

Zollstellung



## Technical data

Suitable for

Kingpin weight

Max. Axleload / axle

Gross trailer weight

Empty weight

Payload

Fifthwheel height

Chassis height

Tyresize

Electrical connectors

Steeringaxle on axle

Liftaxle on axle

Customs-position

## CT-511-S

20 ft  
2x 20 ft  
40 ft (HC)  
45 ft (optional)

17.000 kg

9.000 kg

53.000 kg

8.100 kg

44.900 kg

1.110 mm

1.110 mm

385/55  
R22,5

15 pin only

2, 5

1,2,3,5

## CT-F21-S

20 ft

17.000 kg

9.000 kg

35.000 kg

3.700 kg

31.300 kg

1.110 mm

1.110 mm

385/55  
R22,5

15 pin only

2

-

## CT-R31-S

20 ft

17.000 kg

9.000 kg

44.000 kg

4.500 kg

39.500 kg

1.110 mm

1.110 mm

385/55  
R22,5

15 pin only

3

1,3

## OPTIES / OPTIONEN / OPTIONS

05-17

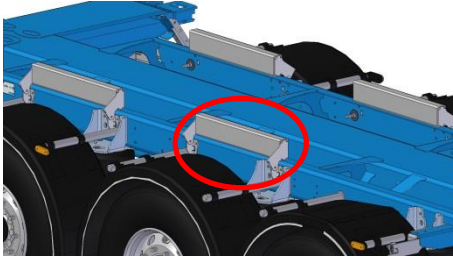

07-1



07-2

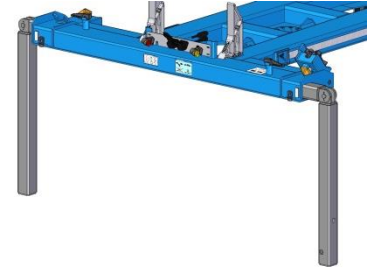

15-14

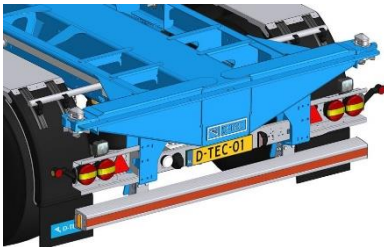

15-15



07-NS-39

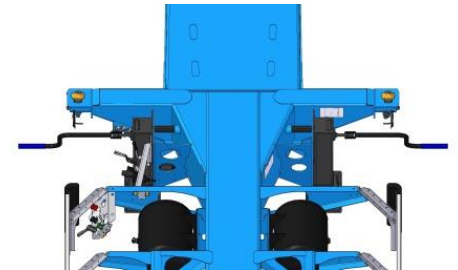

07-NS-12/13/14



07-NS-9

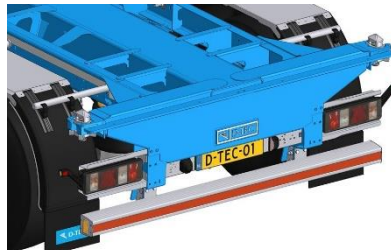

21-3

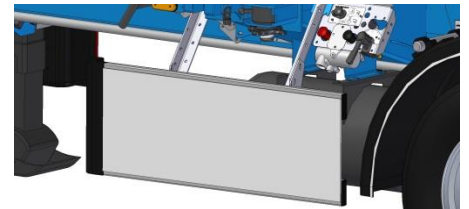

05-9





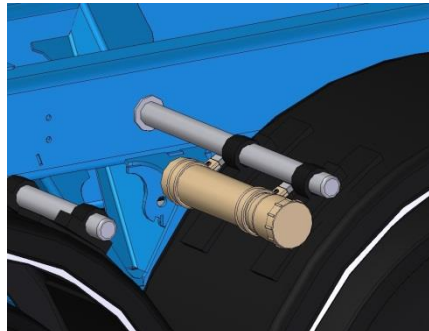

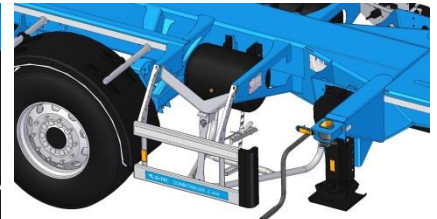

17-7



17-19



 <b>Basis opties</b>		 <b>Basis Optionen</b>		 <b>Basic options</b>	
11-4-15	Valx trommelremmen Standard 2-layer coating in RAL 3002, RAL 5002,	11-4-15	Valx Trommelbremsen RAL 5010, RAL 5015, RAL 7016,	11-4-15	Valx drumbrakes RAL 7021, RAL 9005
09-1-2	Schooperen bovenzijde	09-1-2	Spritzverzinken Oberseite	09-1-2	Schooping topside
21-5	Wielkeggen (4x)	21-5	Radkeile (4x)	21-5	Wheelwedges (4x)
 <b>Comfort opties</b>		 <b>Komfort Optionen</b>		 <b>Comfort options</b>	
11-NS-15	SAF schijfremmen	11-NS-15	SAF Scheiben	11-NS-15	SAF discbrakes
17-8-2	Centrale smering	17-8-2	Zentralschmieranlage	17-8-2	Auto greasing system
05-9	45 ft positie	05-9	45 ft Position	05-9	45 ft positie
13-9	Voeding EBS ook via remlichten	13-9	Strom EBS auch über Bremse	13-9	Power for EBS by brakelights too
19-55-65	Voorstuk met 385/55 en achterstuk met 385/65	19-55-65	Vorderteil auf 385/55, Hinterteil mit 385/65	19-55-65	Front part 385/55, Rear part 385/65
19-65	Bandenmaat 385/65R22,5 Hankook / Continental HTR2	19-65	Reifengröße 385/65 R22,5 Goodyear LHT II / GT /	19-65	Tyresize 385/65 R22,5 Bridgestone / Michelin
19-7-5	Alcoa DB	19-7-5	Alcoa DB	19-7-5	Alcoa DB
19-9-3	Aluminium velgen Reserwiel (staal) met band	19-9-3	Aluminium Felgen Reserverad Stahlfelge	19-9-3	Aluminium rims Sparewheel (steel) with tyre
09-1-1	Schooperen volledig 4 of 6 ronde 3-kamer lampen	09-1-1	Spritzverzinken völlig 4 oder 6 ronde Rückleuchten	09-1-1	Schooping full 4 or 6 round 3 chamber rear lights
15-16	Alle lampen in led uitvoering	15-16	Komplete Beleuchtung in LED	15-16	All lights at the rear in LED
05-17	Klapkokers ivm geen tunnel	05-17	Klappstützen wegen ohne Tunnel	05-17	Filling pieces due to no tunnel
07-1	Kunststof gereedschapskist links	07-1	Kunststoff Werkzeugkasten links	07-1	Plastic toolbox
07-2	Steunpoten in de kopbalk	07-2	Stützen im Frontbalken	07-2	Legs in frontbeam
07-3	Kingpenslothouder 2x	07-3	Halter für Königszapfenverriegelung 2x	07-3	Holder for kingpinlock 2x
07-5	Gevaarlijke stoffen bord	07-5	Gefahrtschild	07-5	ADR sign at the rear, orange
07-28	A-bord 2x	07-28	A-Schild 2x	07-28	A-sign (waste) 2x
07-NS-9	Reclameplaat (alleen op achterstuk)	07-NS-9	Werbungstafel Stahl (nur am Heckteil)	07-NS-9	Steel plate (only at rear part)
17-19	Reserwielendrager	17-19	Reserveradträger	17-19	Sparewheelcarrier
17-22	Antispray achterstuk (385/65)	17-22	Anti-spray Hinterteil (385/65)	17-22	Anti-spray rearpart (385/65)
17-7	Documenten koker uit plastic	17-7	Dokubox Kunststoff	17-7	Document tube
21-3	Zijbeplating witte trespa	21-3	Seitl. Unterfahrschutz Trespa, weiß	21-3	Trespa sidefenders, white
21-8	Kingpinslot	21-8	Königszapfenverriegelung	21-8	Kingpinlock
13-8	België: testnippels voor remdrukken	13-8	Nür für BE	13-8	BE only
25-NS-2	LZV uitgevoerd en gekeurd	25-NS-2	nur für NL	25-NS-2	NL only
17-2	ADR/VLG uitvoering incl certificaten	17-2	nur für NL	17-2	NL only
11-18	Multifunctioneel display	11-18	Multifunktionales Display	11-18	Multifunctional Display





